

8 7 6 5 4 3 2 1

D

D

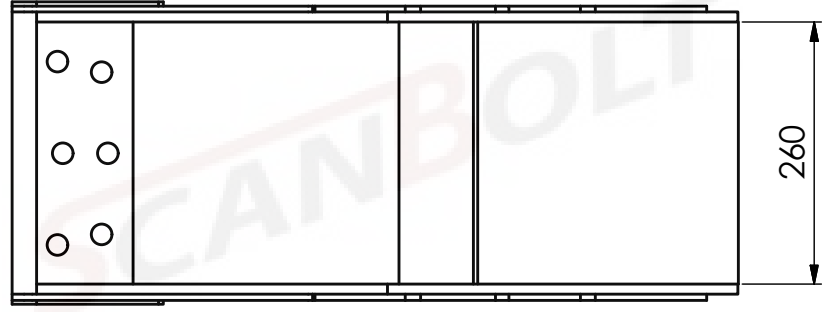

260

C

C

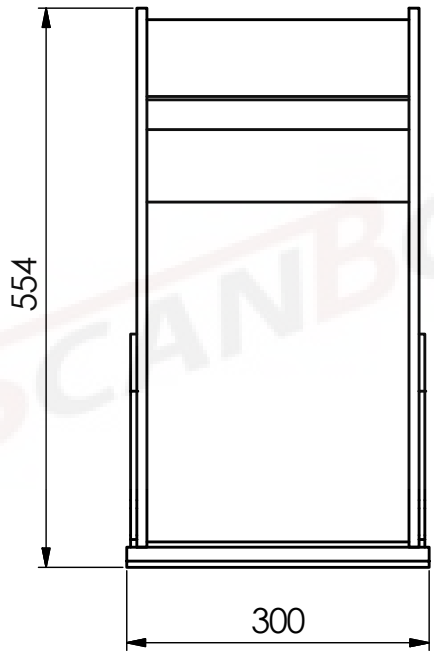

554

300

B

B

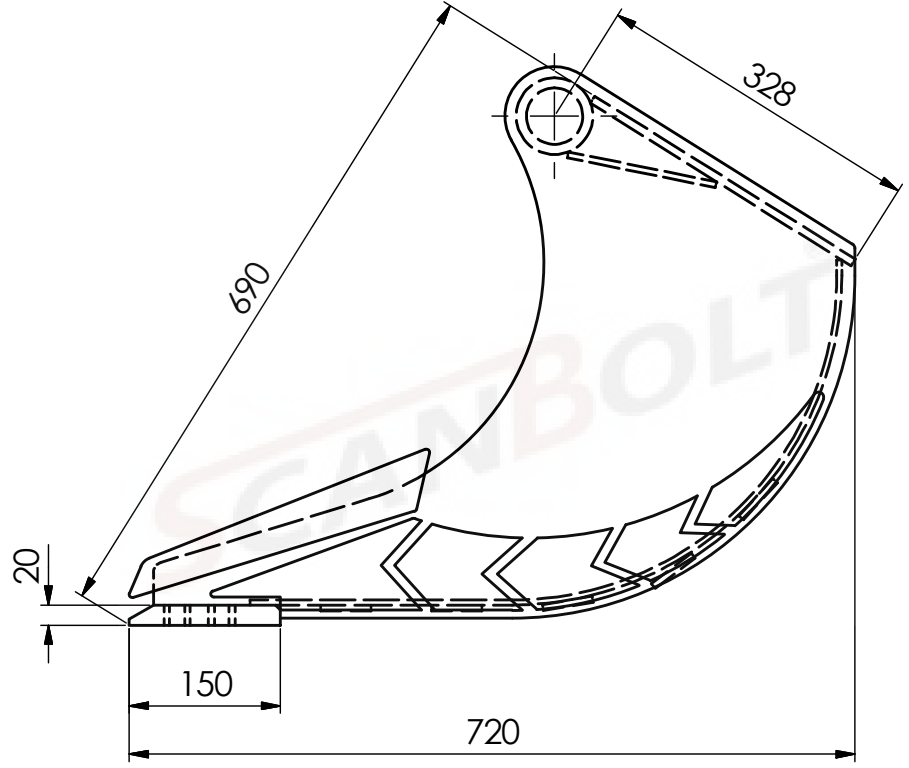

690

328





150

20

720

A

A

| MATERIAL SPECIFICATION | |
|--|-----------------|
|  | ST52.3 |
|  | EN8D |
|  | HB 400 |
|  | HB 450 |
|  | CASTALLOY STEEL |

| SCANBOLT® | |
|------------------|---------------------|
| DESCRIPTION | 30CM DIGGING BUCKET |
| MACHINE CLASS | 3.5 - 4.9 TON |
| WEIGHT | 61.4 Kg |
| HEAPED CAPACITY | 60.5 LITERS |

8 7 6 5 4 3 2 1